

INSTANLLATION MANUAL

1. The tray is designed to position at a corner. The floor drain need to be a feasible position.
2. Connect drainpipe with the drainer bendon the tray and insert the other end into drain hole on the ground.
3. Move the tray at a suitable place and level tray with leveling pole. If it is not level, just adjust screw to level it and fasten lock nuts.
4. Drill holes on the wall. And insert setscrew to fixed the aluminum strip.
5. Fixed the two side-fixed glass,and drill holes on the side aluminum,and fasten the screw.
6. Fixed the centre aluminum,and fasten the screw.
7. Fixed the doorknob on the door. And fixed the door and adjust it. 8. Fixed the magnetic door-strip and the water proof strip.
9. Adjust all the things. And use the silicone to

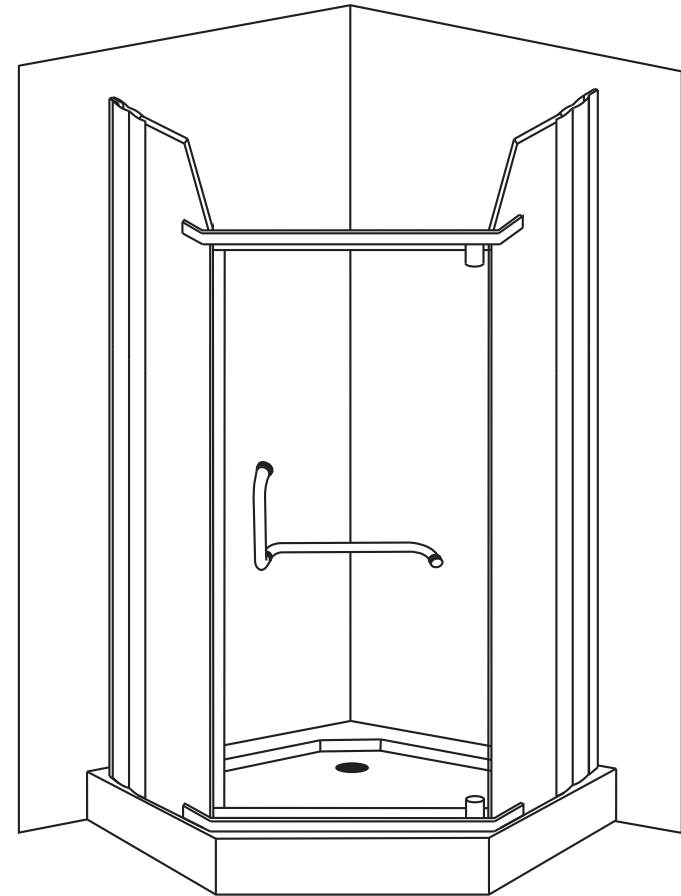

MODEL : ODA-8025

