

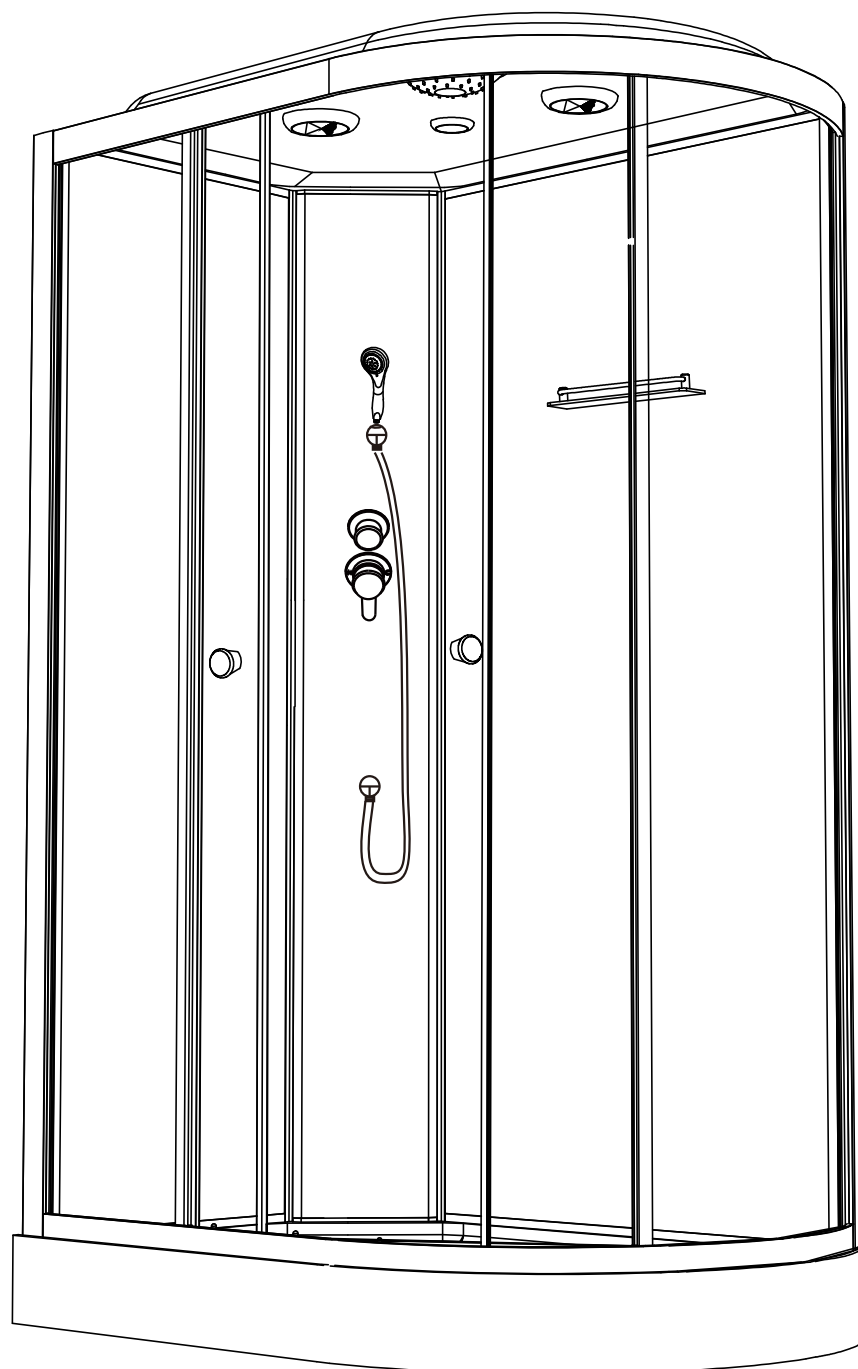

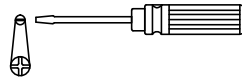

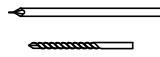

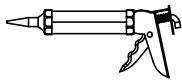

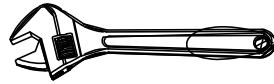

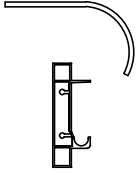
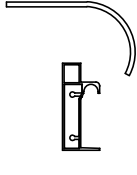
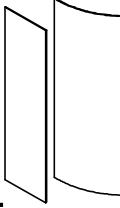
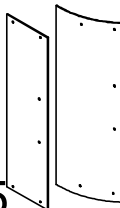
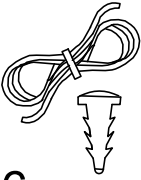
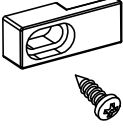
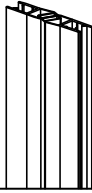

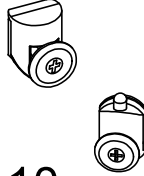
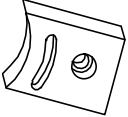

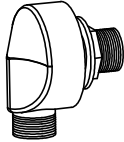

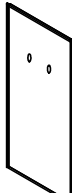

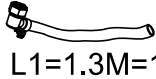

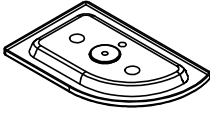
ODA-8407 low pallet L/R

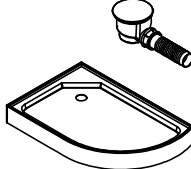
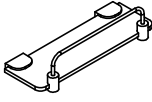

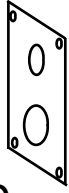

 A1 X2	 A2 X1	 A3 X1	 A4 X1	 A5 X1
 A6 X2	 A7 X4 ST4X10=4	 A8 X1	 A9 X4	 A10 X4
 A11 X8	 A12 X1	 A13 X1	 A14 X1	 A15 X2
 A16 X1	 A17 X1	 A18 X2	 A19 X1 L1=1.3M=1 L2=0.4M=1	 A20 X1
 A21 X1	 A22 X2	 A23 X1	 A24 X1	 A25 X1
 A26 X1 L1=1.5M	 A27 X1	 A28 X1 M4X25=2	 A29 X1	 A30 X4 ST4*20
 ST4X50=8 ST4X12=40				

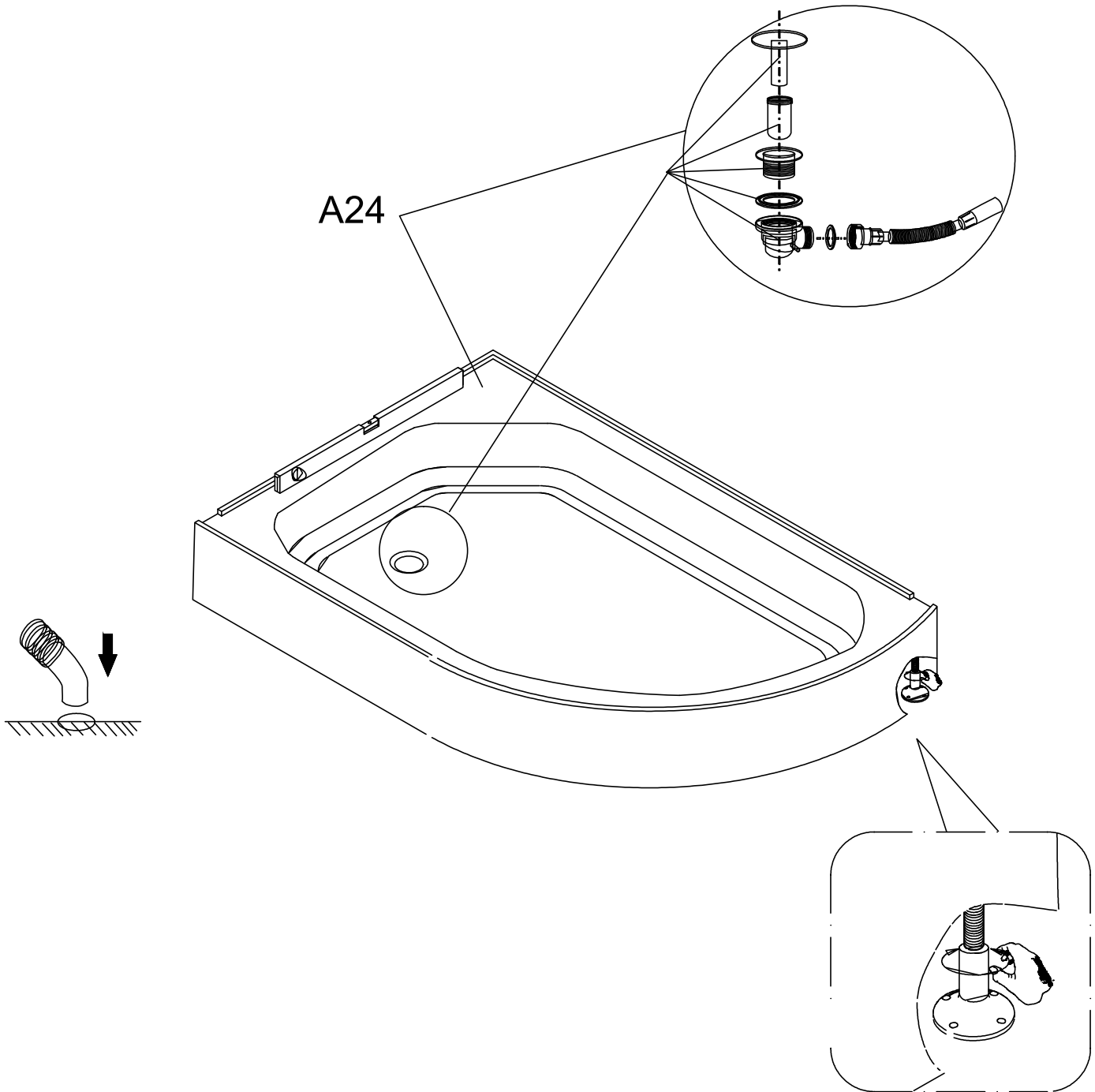
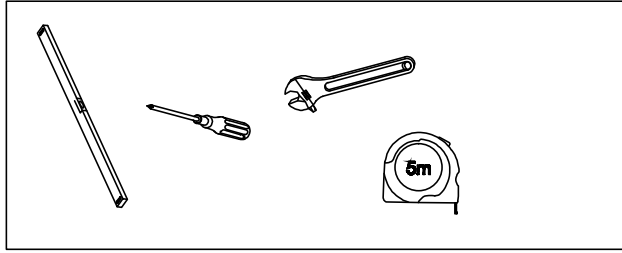
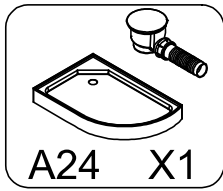

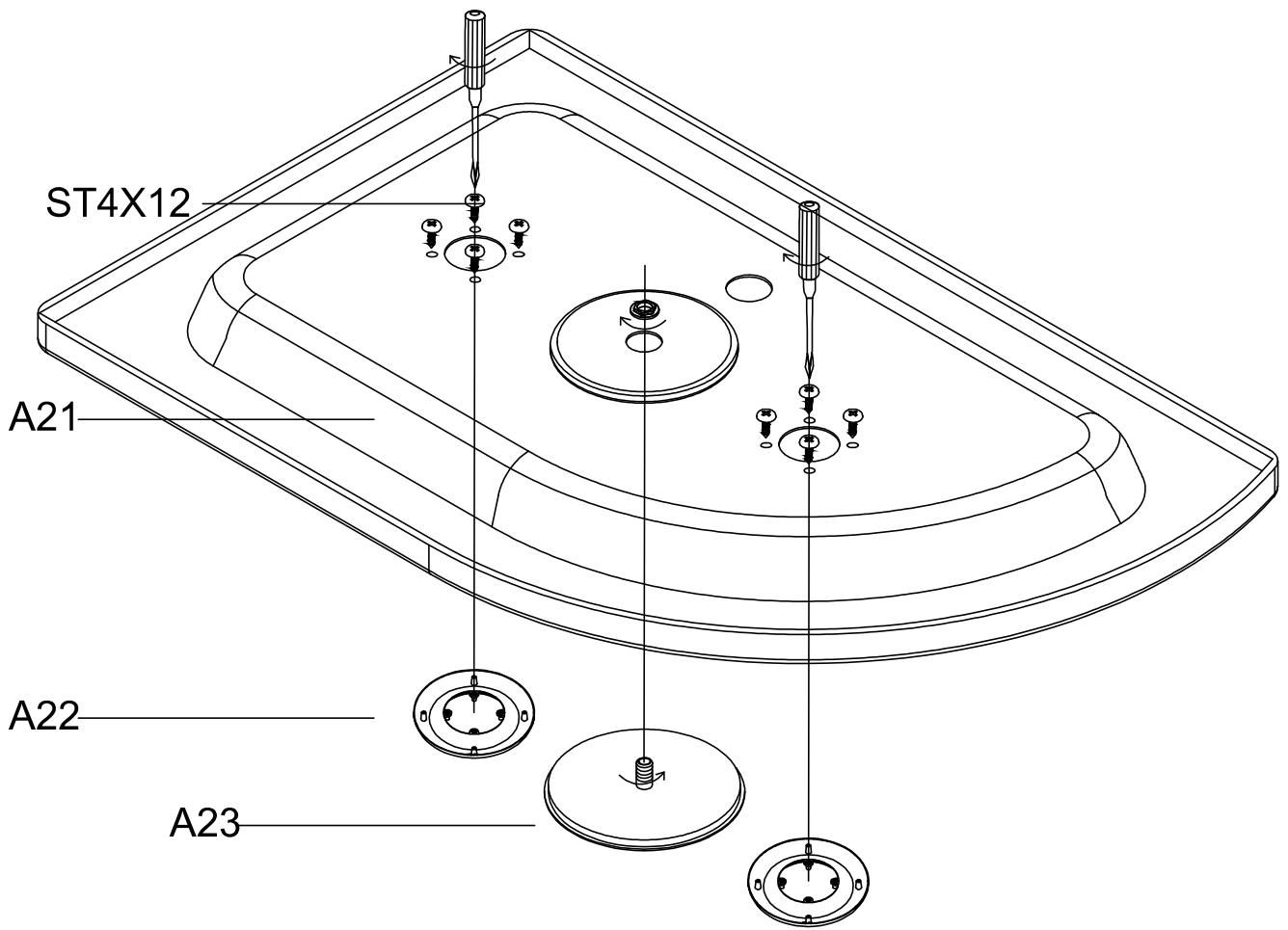
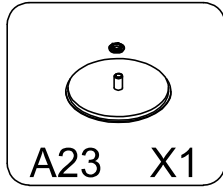
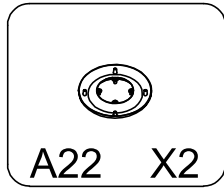
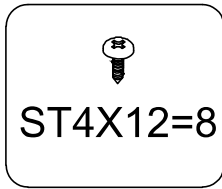
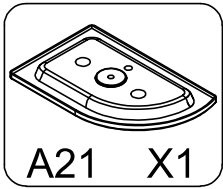

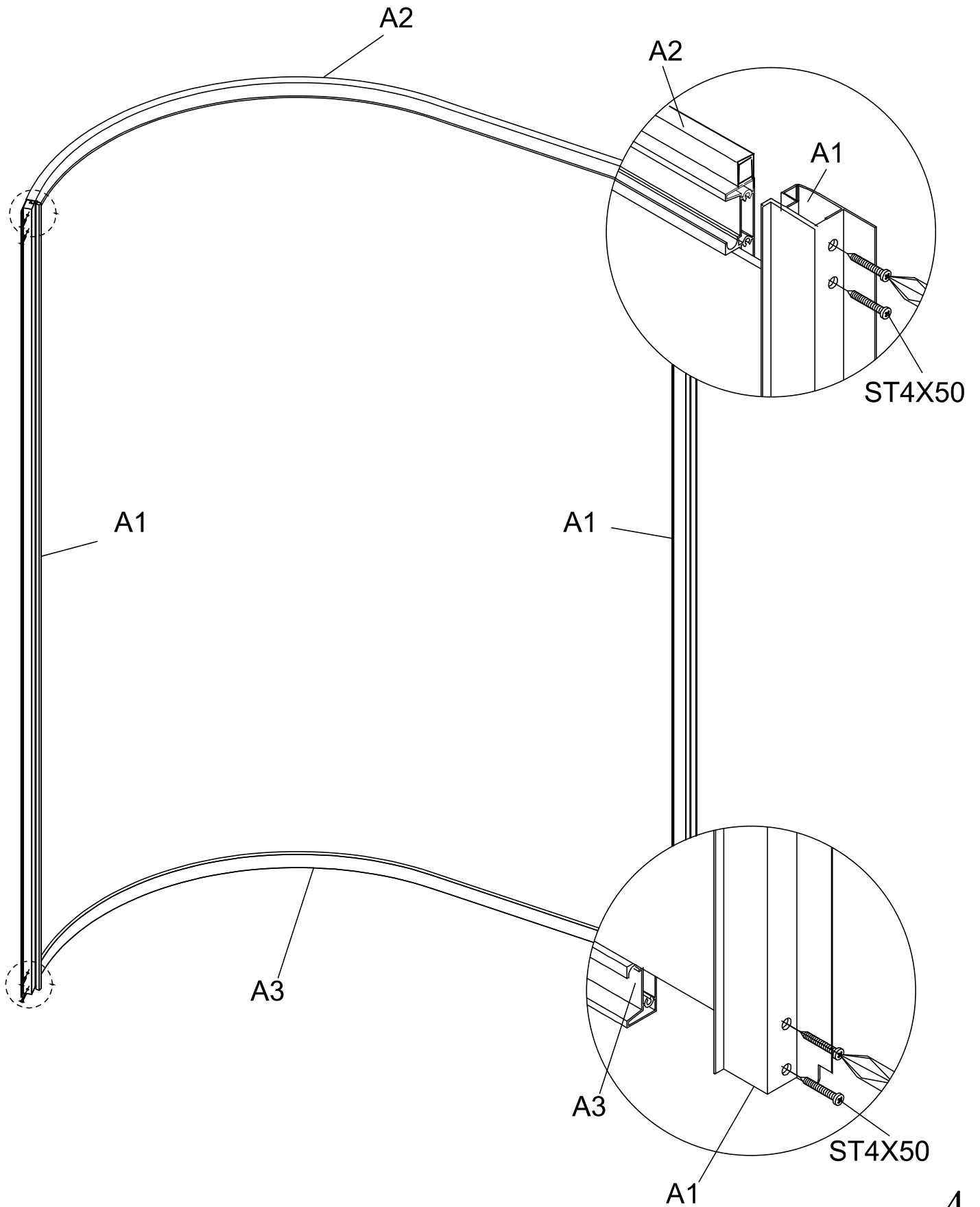
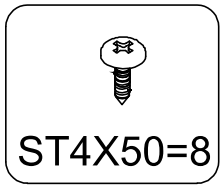
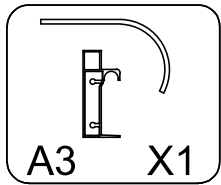
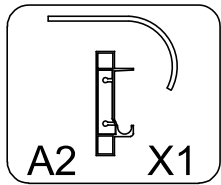
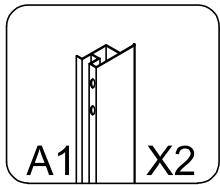

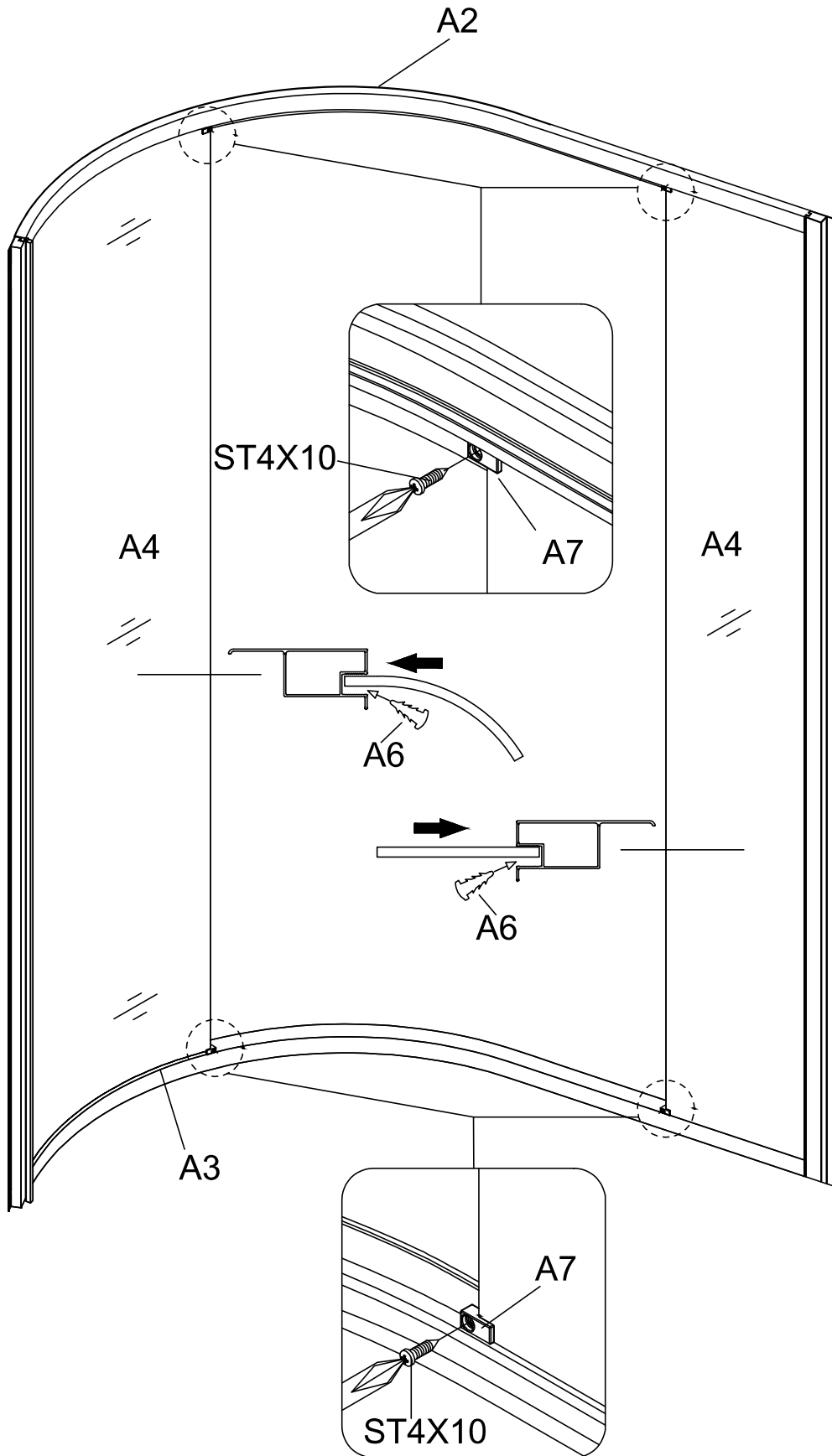
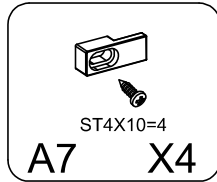
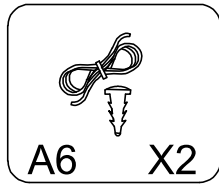
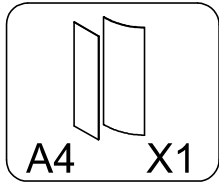

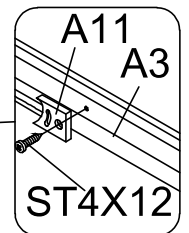
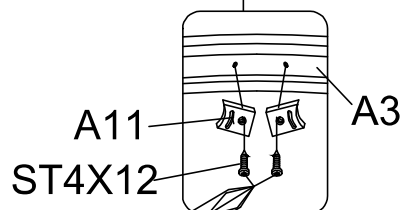
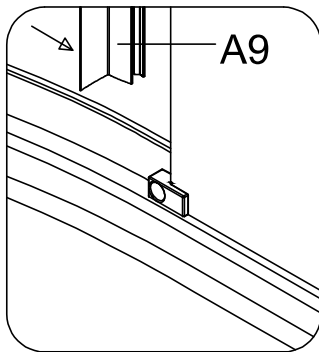
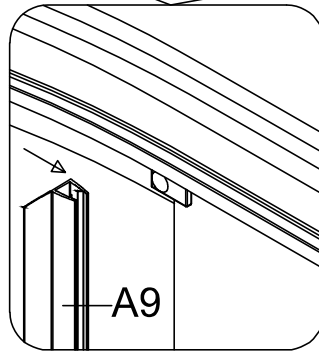
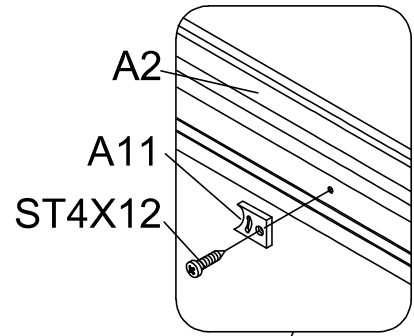
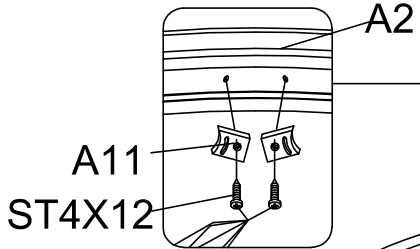
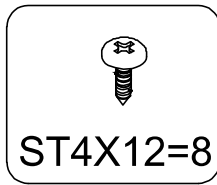
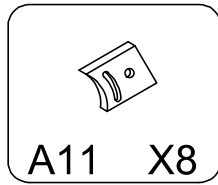
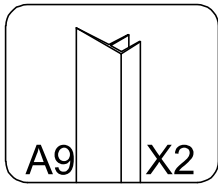

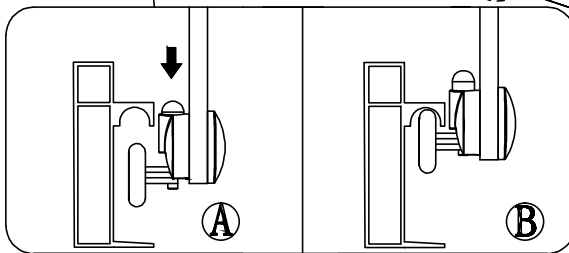
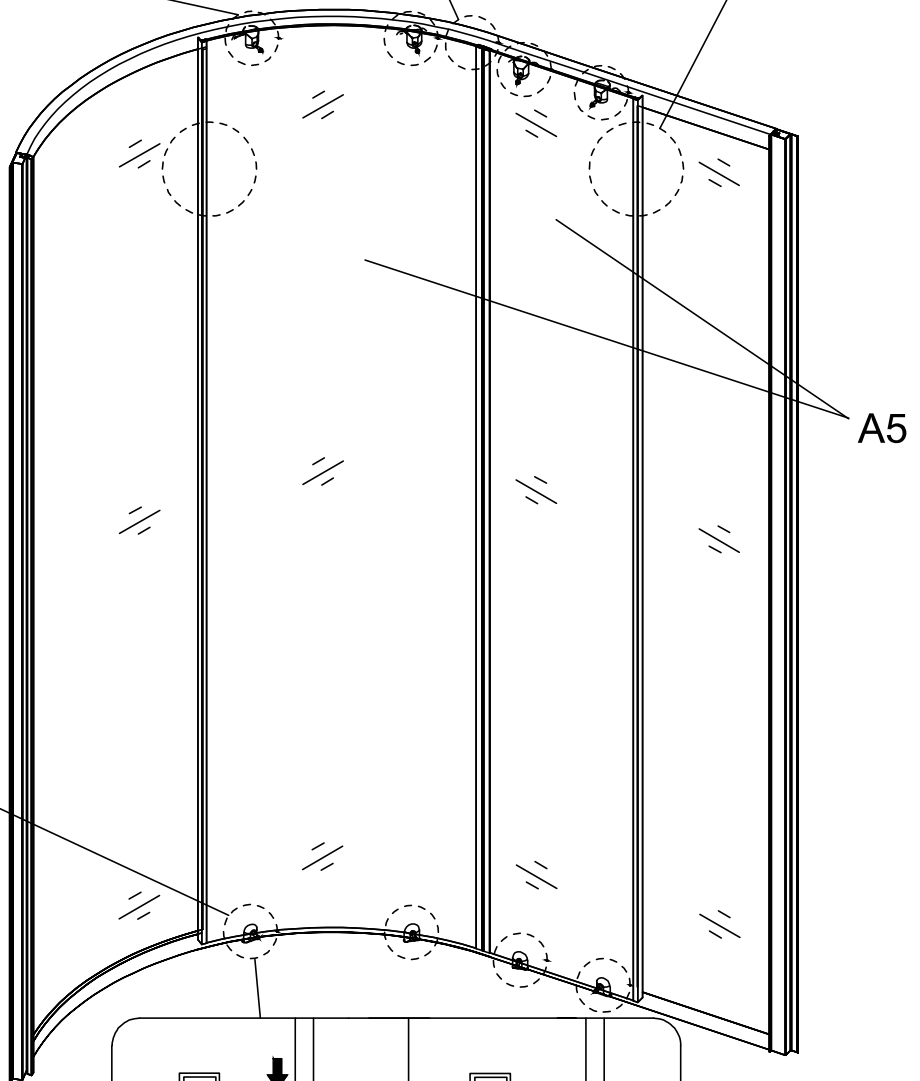
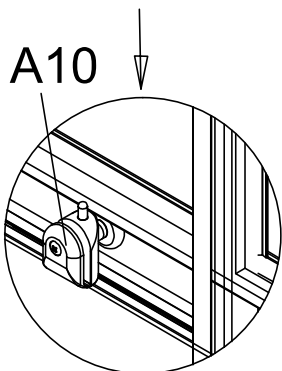
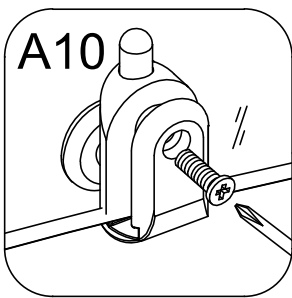
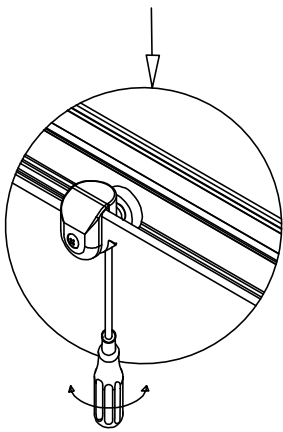
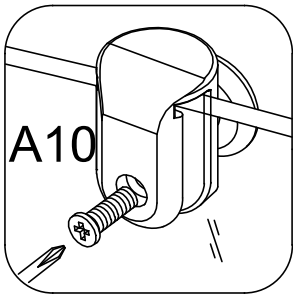
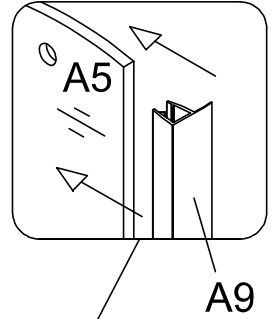
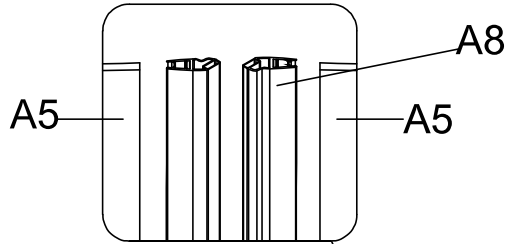
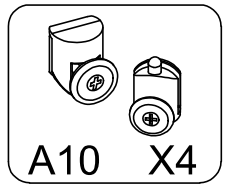
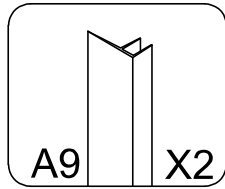
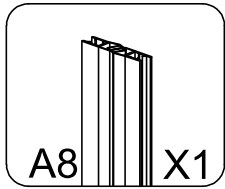
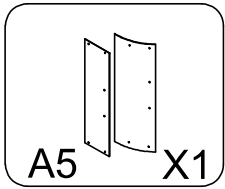

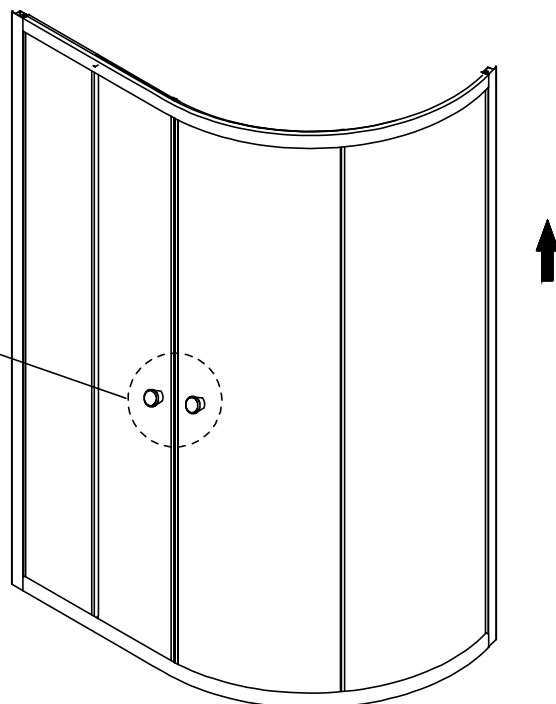
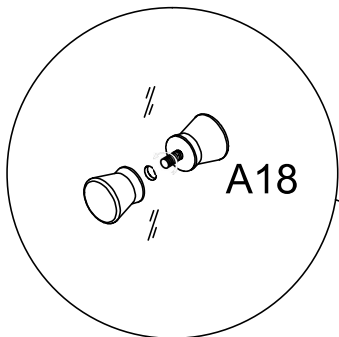
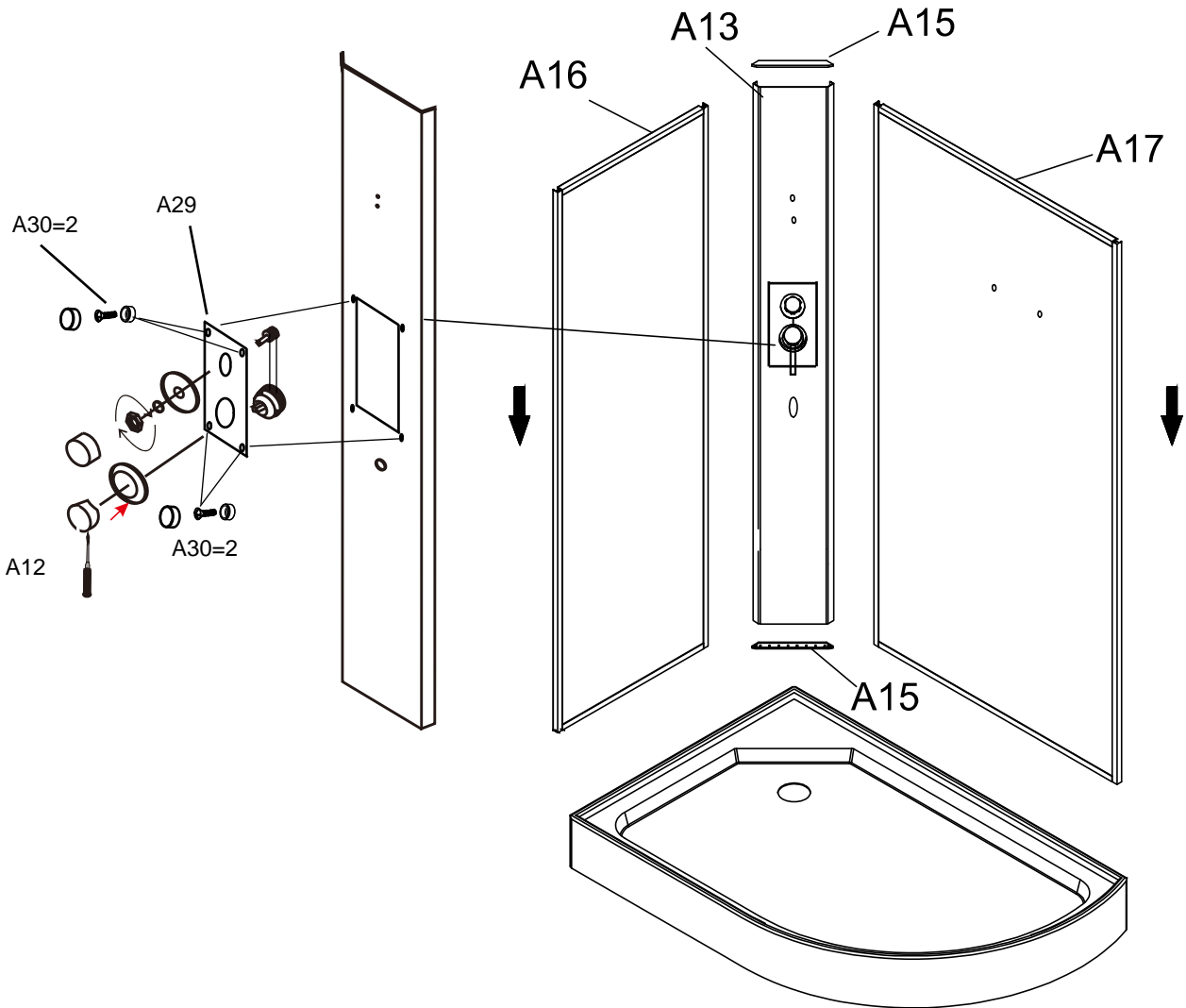
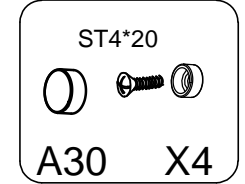
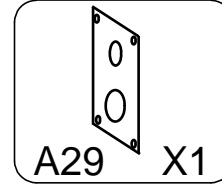
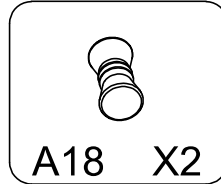
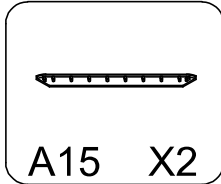
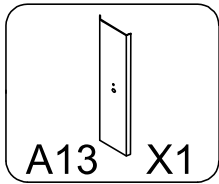
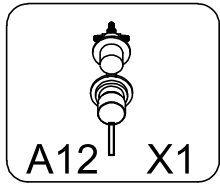

ST4X12=20



L1=1.3M=1
L2=0.4M=1
A19

A20 X2

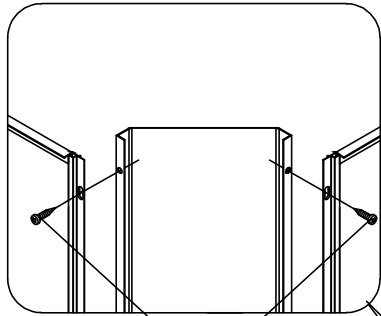

ST4X12

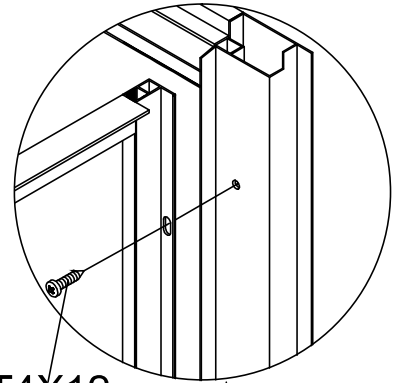

ST4X12

ST4X12=8

ST4X12=8

ST4X12=4

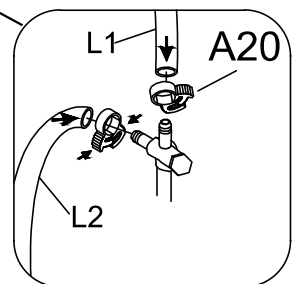

ST4X12=4



A19 L1

A23

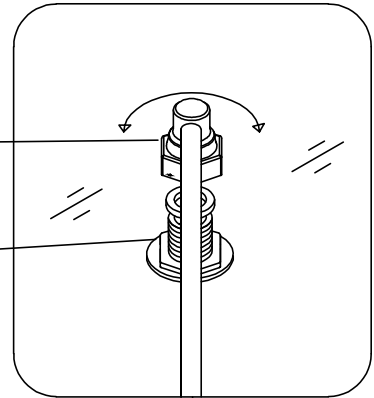

ST4X12=4

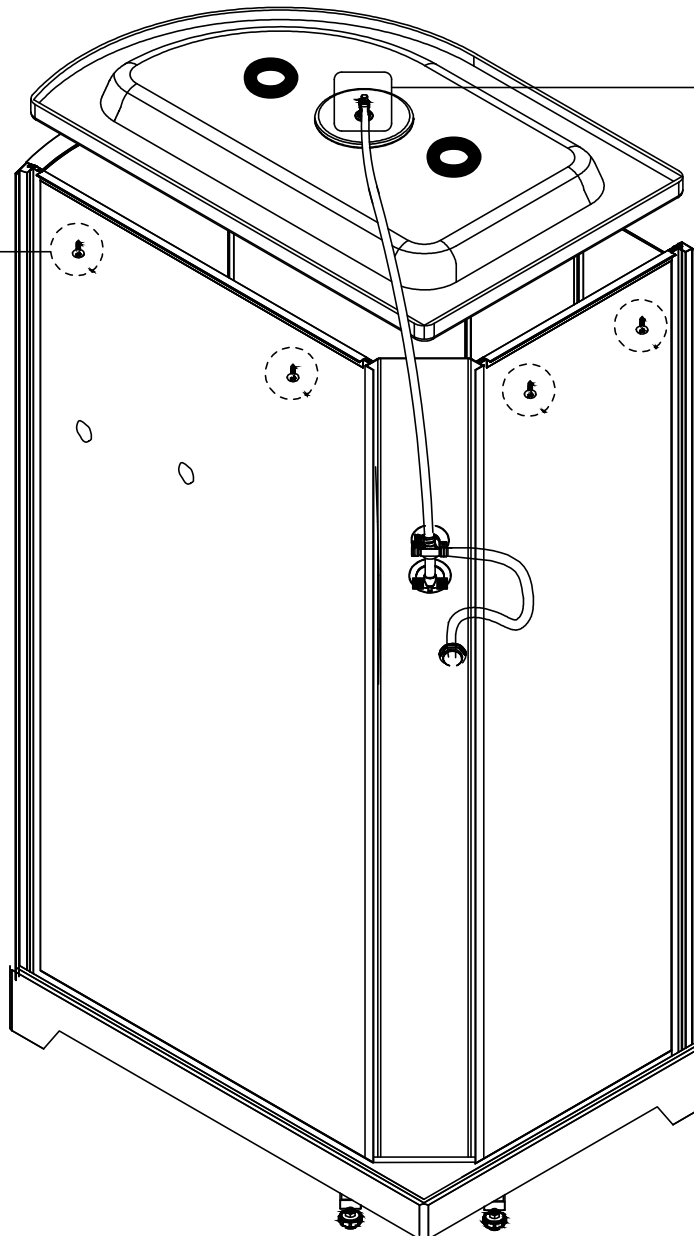

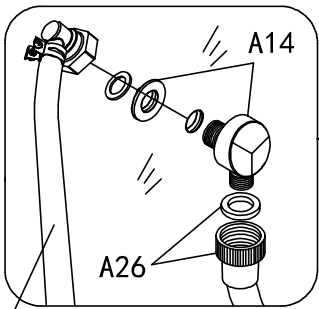
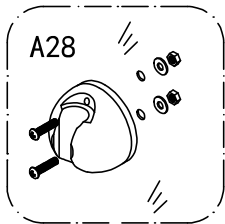
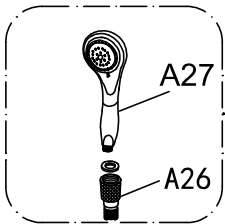
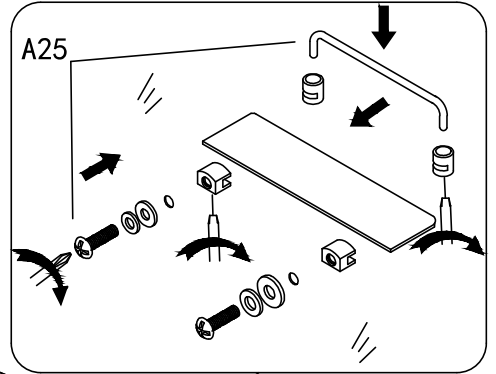
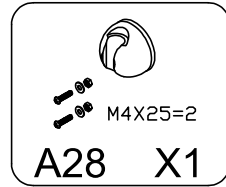
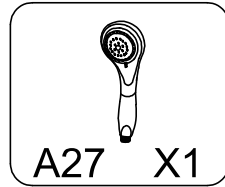
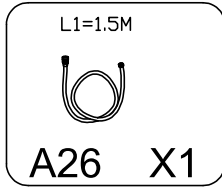
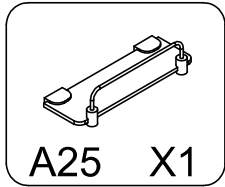
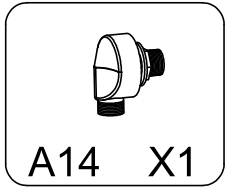

A19
L2

